



## FICHA TÉCNICA

Electroímã 280Kg com temporizador, sinal de estado, LED e câmara de vídeo integrada

- Modelo: YM-280CAM
- Força de tracção: 280Kg
- Voltagem de trabalho: 12 VDC/480mA ou 24 VDC/240mA
- Segurança de pessoas: Abre com falta de tensão
- Com temporizador regulável no fecho
- Com LED indicador de estado
- Caixa em alumínio anodizado
- Magnéticos em aço zincado
- Placa em aço zincado
- Saída de Vídeo: PAL/NTSC
- Tamanho: 280x48x26,5 mm
- Peso: 2,5Kg



YM-280CAM

## Dimensões

Câmara de vídeo

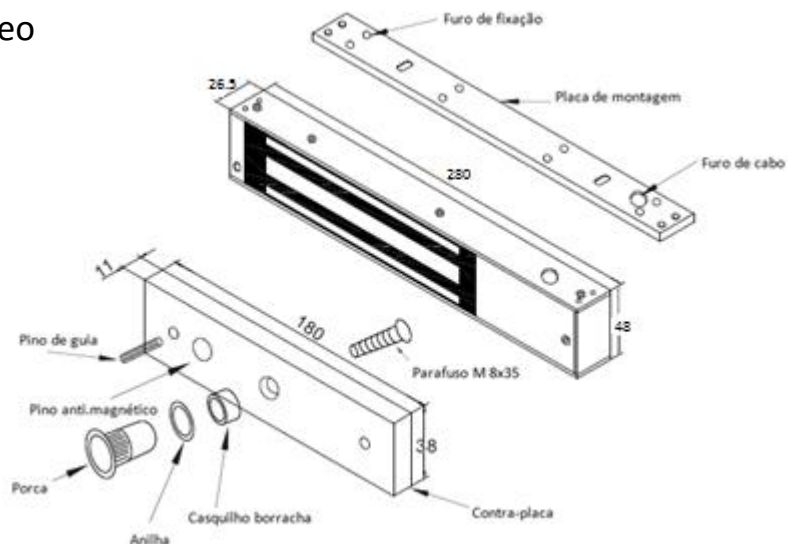
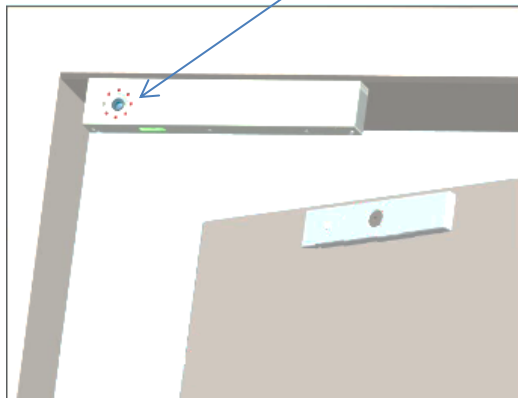



# Triplow

YM-280CAM



## Instalação

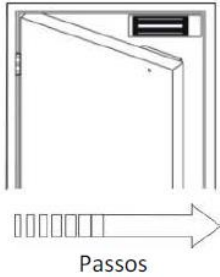

Passos

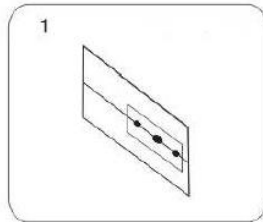

1 Escantilhão

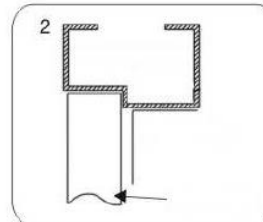

2 Feche a porta, encoste o escantilhão no aro

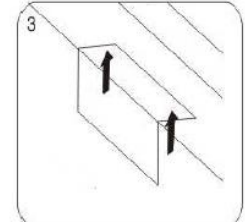

3 Marque os furos no Aro e na porta

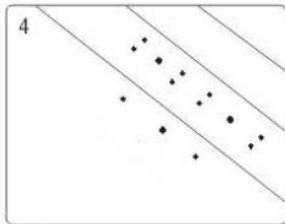

4 Fure com a broca adequada

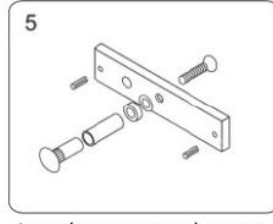

5 Instale a contraplaca na folha da porta

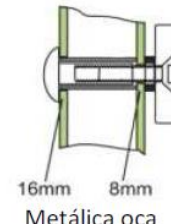

16mm 8mm  
Metálica oca  
Furo int. 8mm  
Furo ext. 16 mm

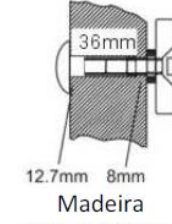

36mm  
12.7mm 8mm  
Madeira  
Furo int. 8mm  
Furo ext. 13 mm



6.8mm for M8-1.25 thread  
Chapeada  
Furo int. 8mm

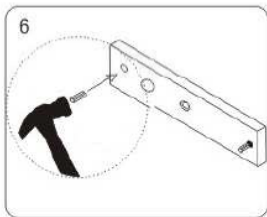

6 Coloque os pinos na contra-placa

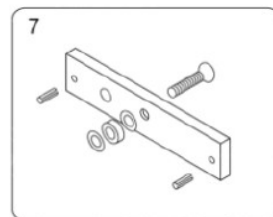

7 Coloque as anilhas na contra-placa de acordo com o desenho

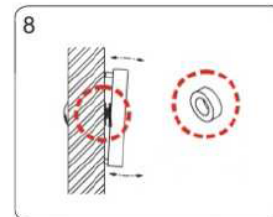

8 Coloque as anilhas entre a contra-placa e a porta

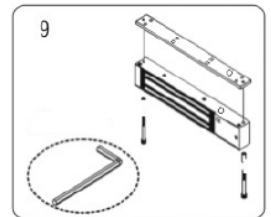

9 Use a chave sextavada para remover a placa de montagem

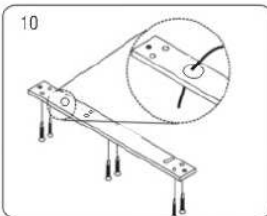

10 Passe o cabo pelo furo e aperte a placa no aro

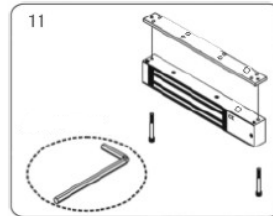

11 Aperte o corpo da fechadura à placa

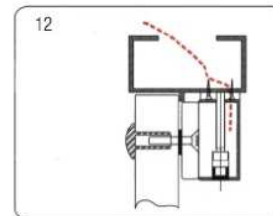

12 Feche e puxe a porta para testar a força de tração

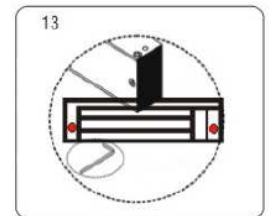

13 Reaperte os parafusos de fixação





### Instalação de esquadros

#### Esquadro em L

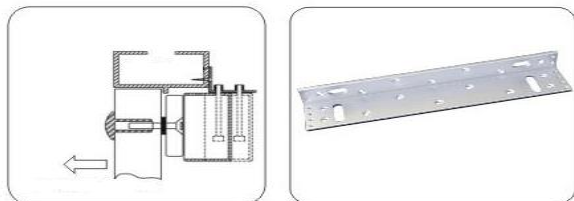

Quando o aro porta tem largura inferior a 42 mm ou a porta abre para fora é necessário instalar o esquadro L

#### Esquadro em ZL

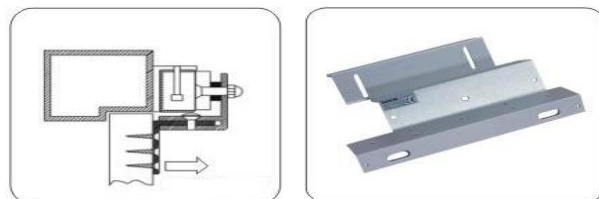

Quando a porta abre para o interior é necessário instalar o esquadro ZL

#### Esquadro em U

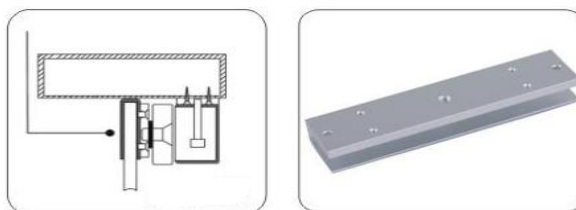

Para portas em vidro temperado de 10 a 15 mm de espessura é necessário usar a luva em U

### Instruções de instalação



Fixação Directa

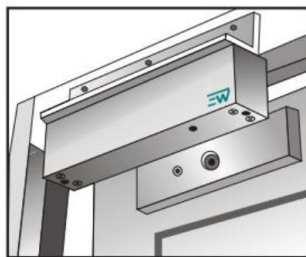

Esquadro L

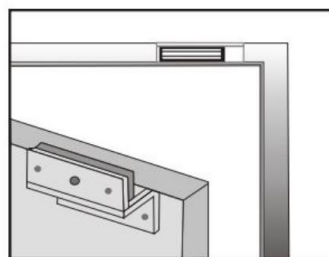

Esquadro ZL

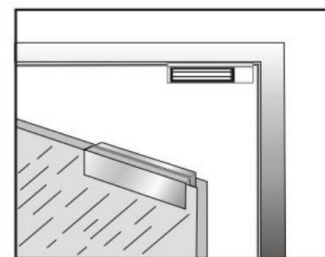

Esquadro U (vidro)





# Triplow

YM-280CAM



## Configuração da Alimentação

Temporizador no fecho: 0, 3, 6 e 9 segundos. 0 segundos, por defeito

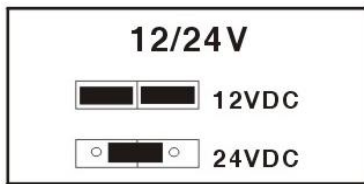

Configuração dos comutadores internos para 12 ou 24 VCD

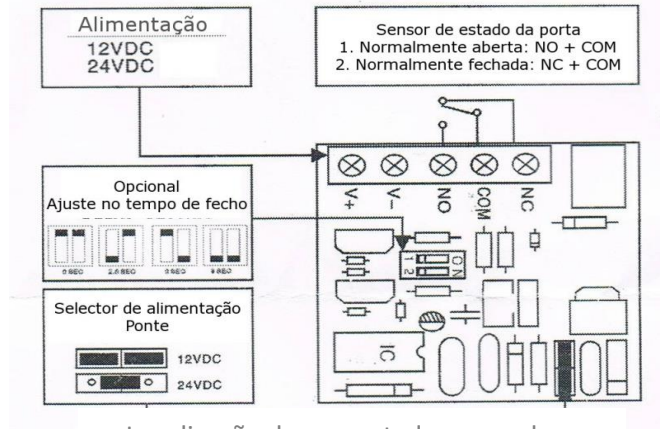

Localização dos comutadores na placa principal de YM-350T(LED)

## Esquema eléctrico

### Fechadura Electromagnética



### Fonte de Alimentação

12 /24 VCD GND Push NO NC

Botão de Saída (NO)

### Controlador de Acesso

(Teclado Numérico, Cartão RF, Control Remoto, etc.)

#### Sensor do estado da porta:

Verde: A porta está correctamente fechada

Vermelho: A porta está mal fechada

Sem luz: A porta está em uso ou sem corrente (porta aberta)





# Triplow

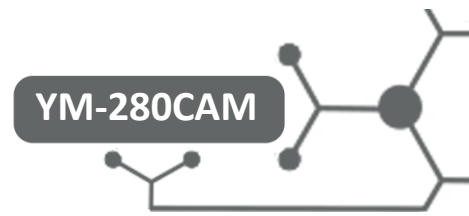

## Garantia

Todos os produtos comercializados pela Triplow W, Lda. possuem garantia de dois anos contra defeitos de fabrico.

Todos os equipamentos vendidos são, em caso de avaria, verificados nas nossas instalações e no caso de não serem reparáveis, são substituídos por outros novos, ao abrigo da garantia respectiva.

Para mais informações consulte as nossas condições de venda em:

<http://www.triplow.pt/catalog/conditions.php>

